

TV INTERFACE

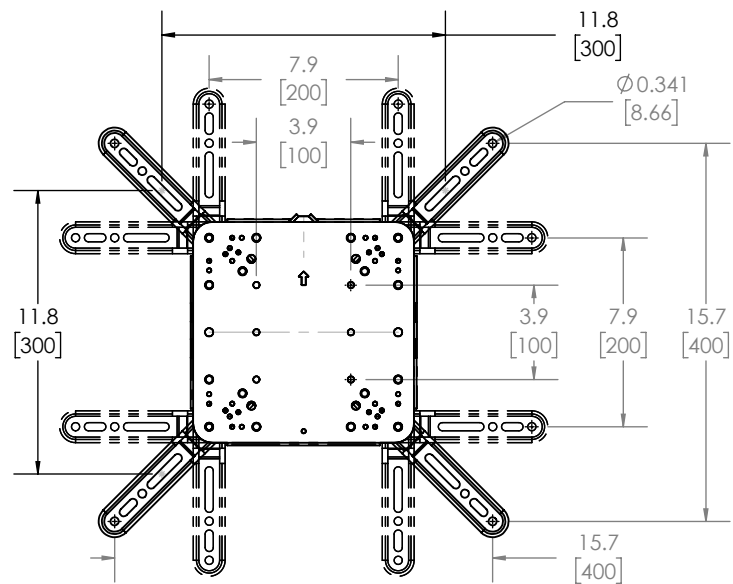

MEDIUM FULL MOTION 6805-002299

THE INFORMATION AND DESIGNS CONTAINED IN THIS DRAWING ARE CONFIDENTIAL AND THE PROPRIETARY PROPERTY OF MILESTONE AV TECHNOLOGIES NEITHER THIS DESIGN NOR ANY INFORMATION CONTAINED IN THIS DRAWING MAY BE REPRODUCED OR DISCLOSED TO OTHERS WITHOUT THE EXPRESS WRITTEN CONSENT OF MILESTONE AV TECHNOLOGIES. 本图纸所包含的信息和设计均系 Milestone 机密和知识产权, 本图纸包含的设计和信
息在未经 Milestone 允许情况下均不得复制或泄露

3-D

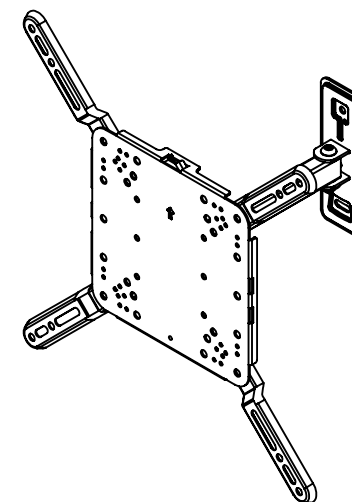

WALL PLATE

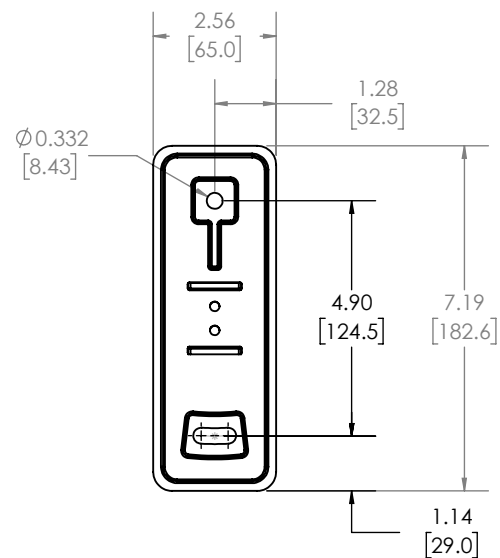

TOP VIEW - EXTENDED

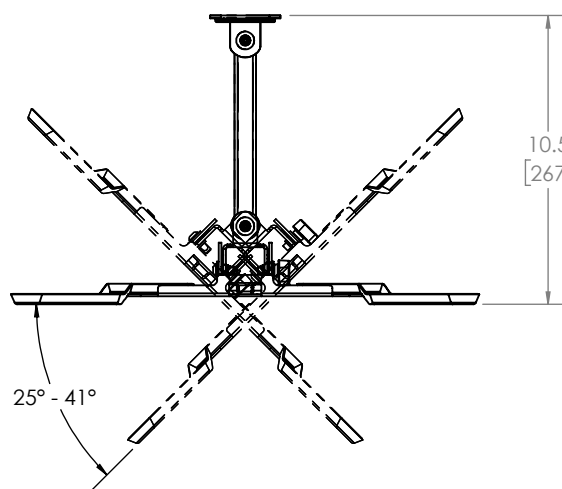

SIDE VIEW - EXTENDED

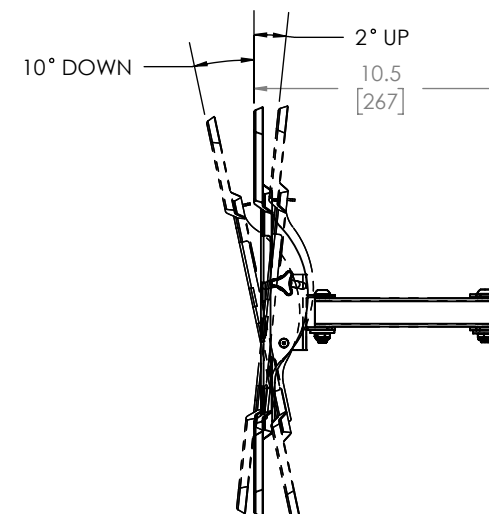

FULLY ASSEMBLED MOUNT

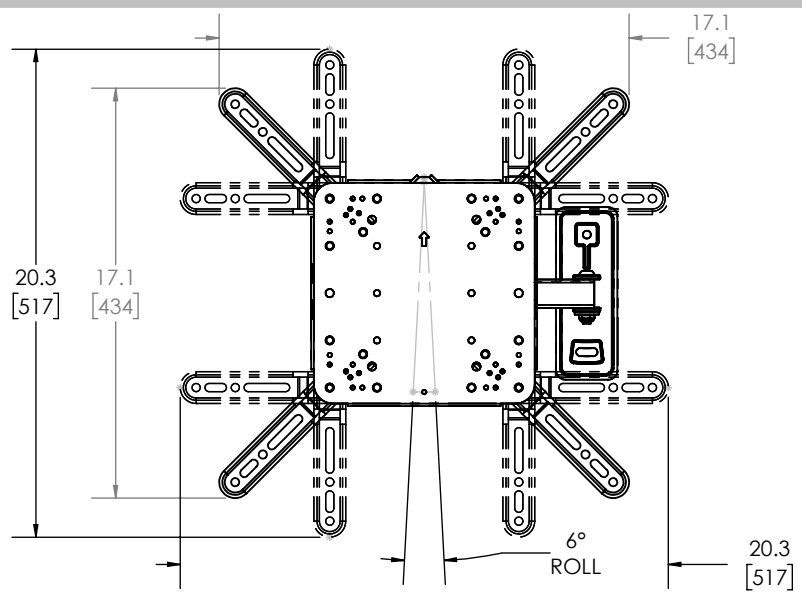

TOP VIEW - RETRACTED

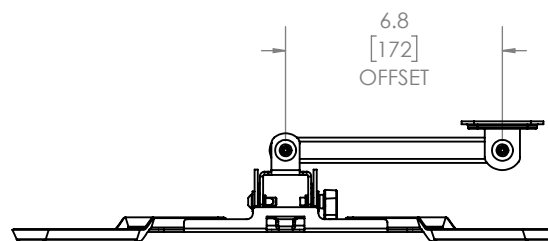

SIDE VIEW - RETRACTED

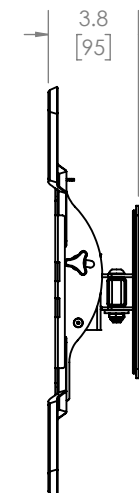

TV INTERFACE

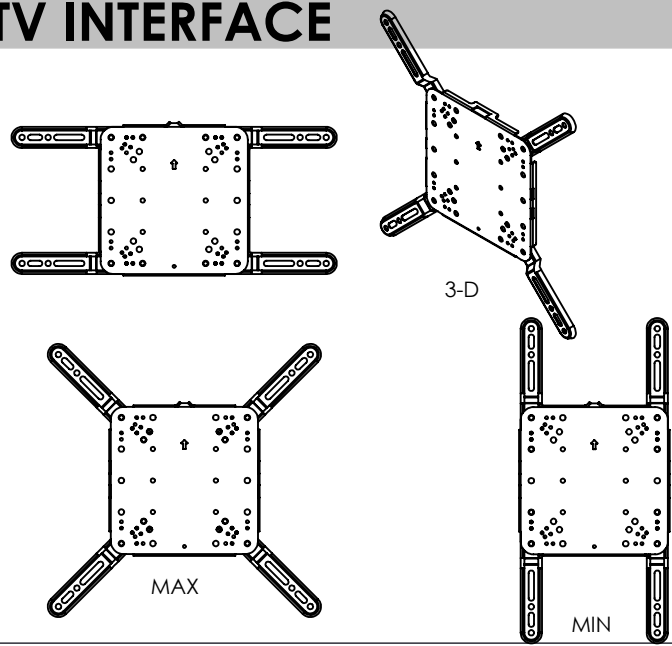

NOT FOR WEB USE!!

3-D

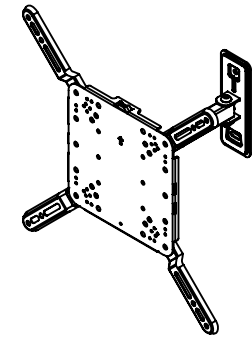

3-D, EXTENDED, INTERFACE MID POSITION

WALL PLATE



3-D



LEFT



FRONT

EXTENDED

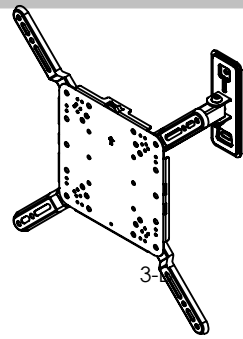

3-D

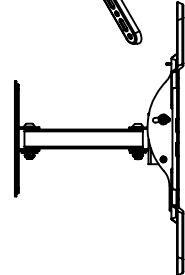

LEFT

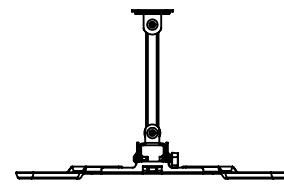

TOP

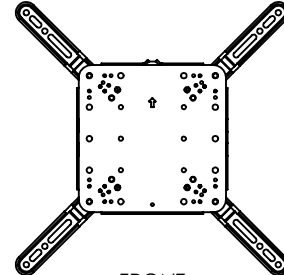

FRONT

TILT

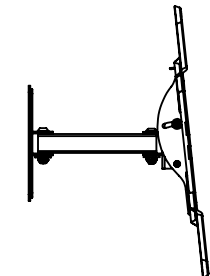

EXTENDED TILT UP

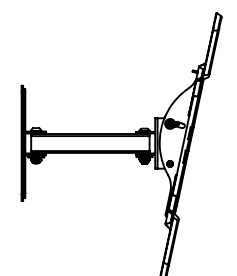

EXTENDED TILT DOWN

RETRACTED

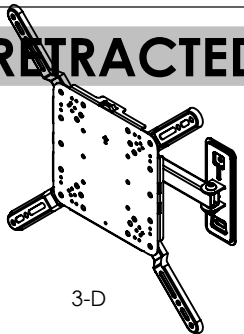

3-D

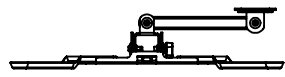

TOP



LEFT

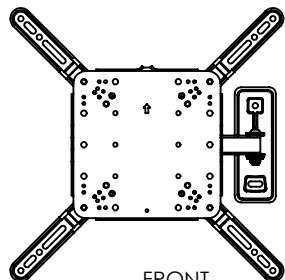

FRONT

SWIVEL

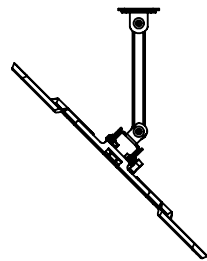

TOP SWIVEL LEFT

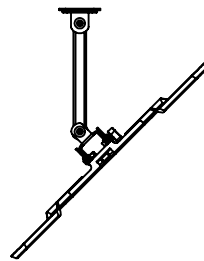

TOP SWIVEL RIGHT

3-D EXPLODED IN-BOX

